

4-way Passive C-band Splitter/Combiner



COM04C2P-2587 is a 4-way passive C-band (5.8 to 6.5GHz) splitter/combiner with DC block on all ports

This component is available with the following RF connector options: 50 Ω SMA & 50 Ω N-type.

Summary table for RF performance over C-band operation, 5.8 GHz to 6.5GHz

Model Numbers	Conn.	Insertion Loss* (dB)		Isolation Typical (dB)	Return Loss (dB)		Phase & Amplitude Misalignment	
		Typ.	Max		Typ.	Min	Φ	Amp(dB)
COM04C2P-2587-S5S5	50Ω SMA	1.2	2.0	23	15	10	4°	0.2
COM04C2P-2587-N5N5	50Ω N-type	1.4	2.8	20	12	8	4°	0.2

* The quoted insertion loss is loss above theoretical due to power split. For 4-way splitters theoretical value is 6dB.

Maximum acceptable operating parameters for reliable and safe operation

Parameter	Value	Comment
Input RF power	+37 dBm (5W)	Max total RF power
DC Voltage	50V	
Operating temperature	0 to 45°C	Indoor use only
Storage Temperature	-20°C to +75°C	
Humidity	85%	Non-condensing

! Operation beyond these limits may cause instantaneous and permanent damage.



COM04C2P-2587

4-way Passive C-band Splitter/Combiner



Vector diagram & physical dimensions

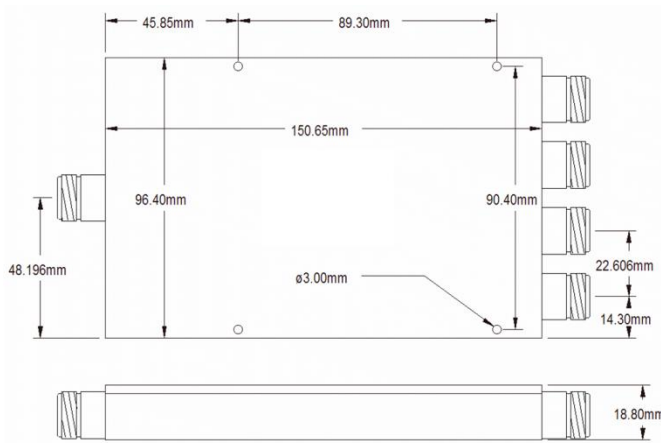
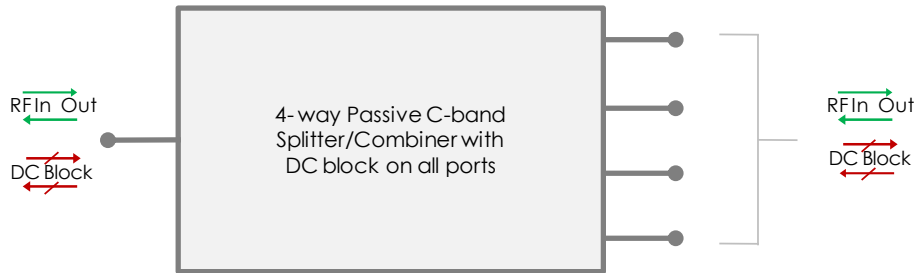

Feature set of 4-way Passive C-band splitters/combiners

Model Number	Frequency	DC Pass/Block
COM04C4P-2553	2.0-4.2 GHz	DC pass on ALL ports
COM04C4P-2585	2.0-4.2 GHz	DC pass on ONE output, DC block on all other outputs
COM04C4P-2589	2.0-4.2 GHz	DC block on ALL ports
COM04C1P-2550	3.4-4.2 GHz	DC pass on ALL ports
COM04C1P-2586	3.4-4.2 GHz	DC block on ALL ports
COM04C3P-2552	3.4-6.5 GHz	DC pass on ALL ports
COM04C3P-2588	3.4-6.5 GHz	DC block on ALL ports
COM04C2P-2551	5.8-6.5 GHz	DC pass on ALL ports
COM04C2P-2587	5.8-6.5 GHz	DC block on ALL ports



ETL Systems Ltd, Coldwell Radio Station, Madley, Hereford, HR2 9NE, England

ETL Systems design, develop and manufacture specialist equipment for satellite ground stations. For a full description of the ETL product range, please see our website at www.etlsystems.com. This product range provides the basis for meeting your specific demands.

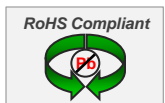

Tel +44 (0)1981 259020
 Fax +44 (0)1981 259021
info@etlsystems.com